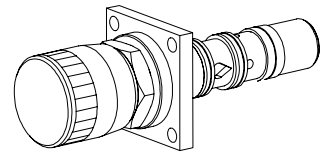

**2-way flow control valve
Slip-in cartridge**

- $Q_{max} = 16 \text{ l/min}$
- $Q_{Nmax} = 16 \text{ l/min}$
- $p_{max} = 250 \text{ bar}$

NG6
 Wandfluh standard

DESCRIPTION

2-way slip-in cartridge-type flow control valve, cavity acc. to Wandfluh standard. The valve is available in two different setting versions: turning knob and lockable type EWA. In this standard form, this control valve can be supplied with four nominal volume flow ranges. The cartridge body is made of steel and phosphatized. The aluminium turning knob is colorless anodized.

FUNCTION

The 2-way flow control valve is designed to keep to oil flow to any actuator constant irrespective of the load. By turning the knob of the variable restrictor the volume flow can be adjusted. If the pressure in the system changes the pressure compensator will change the diameter of the oil passage in order to keep the pressure difference on the measuring orifice constant.

APPLICATION

For use in all hydraulic systems where the supply volume flow needs to be kept constant even when the load fluctuates. Installation of the screw-in cartridge in control blocks as well as in the Wandfluh sandwich plates and flange valves of the NG6 size as a functional element (please refer to the separate data sheets in register 2.5). Cavity tools are available for machining the cavities in steel and aluminium (hire or purchase). Please refer to the data sheets in register 2.13.

CONTENTS

GENERAL SPECIFICATIONS	1
HYDRAULIC SPECIFICATIONS	1
SYMBOLS	1
CONTROL	1
CHARACTERISTICS	2
DIMENSIONS	2
PARTS LIST	2
ACCESSORIES	2

TYPE CODE

		MR602 - <input type="checkbox"/> - <input type="checkbox"/> # <input type="checkbox"/>								
Flow control valve 2-way Turning knob adjustment										
Nominal volume	<table border="0"> <tr> <td>$Q_N = 2,5$</td> <td><input type="checkbox"/></td> </tr> <tr> <td>$Q_N = 6,3$</td> <td><input type="checkbox"/></td> </tr> <tr> <td>$Q_N = 12,5$</td> <td><input type="checkbox"/></td> </tr> <tr> <td>$Q_N = 16$</td> <td><input type="checkbox"/></td> </tr> </table>		$Q_N = 2,5$	<input type="checkbox"/>	$Q_N = 6,3$	<input type="checkbox"/>	$Q_N = 12,5$	<input type="checkbox"/>	$Q_N = 16$	<input type="checkbox"/>
$Q_N = 2,5$	<input type="checkbox"/>									
$Q_N = 6,3$	<input type="checkbox"/>									
$Q_N = 12,5$	<input type="checkbox"/>									
$Q_N = 16$	<input type="checkbox"/>									
Additional marking for lock adjustment	<input type="checkbox"/> EWA									
Design-Index (Subject to change)										

GENERAL SPECIFICATIONS

Description	2-way flow control valve
Construction	Slip-in cartridge for cavity acc. to Wandfluh standard
Mounting	Slip-in cartridge 4 socket head cap screws M5
Ambient temperature	-20...50° C
Mounting position	any
Fastening torque	$M_D = 5,5 \text{ Nm}$ (qual.8.8)
Weight:	$m = 0,5 \text{ kg}$ (knob) $m = 0,6 \text{ kg}$ (lock)

HYDRAULIC SPECIFICATIONS

Fluid	Mineral oil, other fluid on request
Contamination efficiency	ISO 4406:1999, class 18/16/13 (Required filtration grade $\beta_{6...10} \geq 75$) refer to data sheet 1.0-50/2
Viscosity range	12 mm ² /s...320 mm ² /s
Fluid temperature	-20...+70° C
Peak pressure	$p_{max} = 250 \text{ bar}$
Nominal volume flow	$Q_N = 2,5 \text{ l/min}$, $Q_N = 6,3 \text{ l/min}$, $Q_N = 12,5 \text{ l/min}$, $Q_N = 16 \text{ l/min}$
Min. volume flow	$Q_{min} = 0,02 \text{ l/min}$
Max. volume flow	$Q_{max} = 16 \text{ l/min}$
Control accuracy	$\leq 1\%$

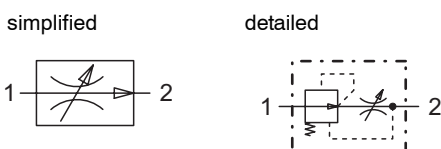
SYMBOLS

CONTROL

Mechanical types of operation in 2 different versions:

- | | |
|-----------|---------------------------------|
| no remark | = Knob adjustment interlockable |
| EWA | = Lock adjustment |

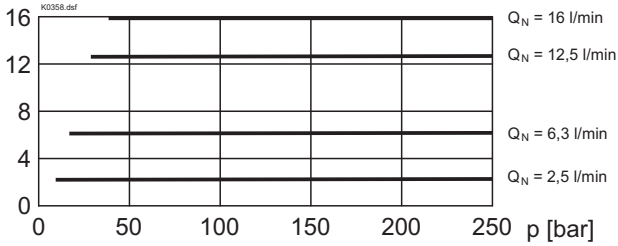
CHARACTERISTICS Oil viscosity $\nu = 30 \text{ mm}^2/\text{s}$
 $Q = f(p)$ Pressure drop / flow characteristic

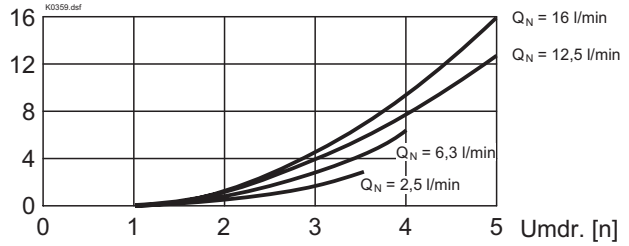
 Q [l/min]

 $Q = f(n)$ Volume flow adjustment characteristics

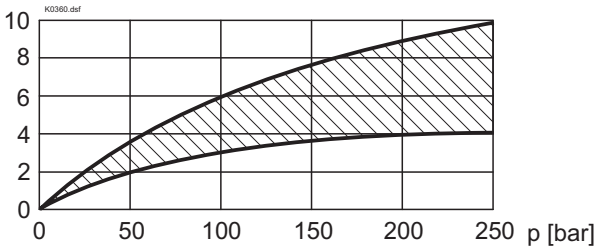
 Q [l/min]

 $Q_L = f(p)$ Leakage volume flow characteristic

 Q_L [cm³/min]

DIMENSIONS

Knob adjustment

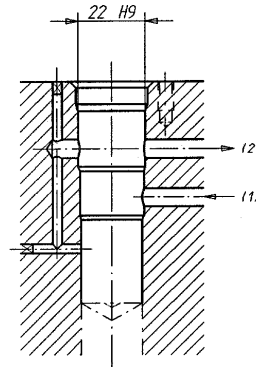
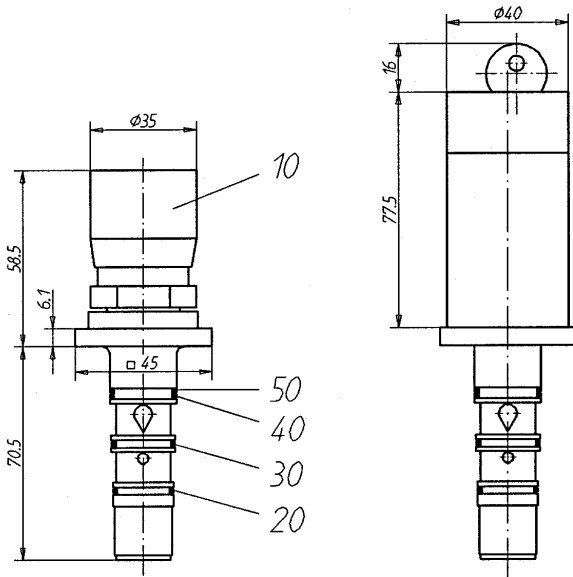
Lock adjustment

Cavity drawing acc. to Wandfluh standard



For cavity details and cavity tools, see data sheet 2.13-1028.

PARTS LIST

Position	Article	Description
10	114.1201	Turning knob
20	160.2156	O-ring ID 15,60x1,78
30	160.2170	O-ring ID 17,17x1,78
40	160.2188	O-ring ID 18,77x1,78
50	49.3226	Back-up ring RD 19,1x22x1,4

ACCESSOIRES

 Cartridge built-in flange- or sandwich plates
 Flange/Sandwich valves

Register 2.5

Technical explanation see data sheet 1.0-100E