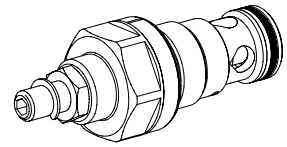

2-way flow control valve
Screw-in cartridge

- **Integrated non-return valve function**
- **Fixed orifice, adjustable pressure compensator**
- $Q_{max} = 50 \text{ l/min}$
- $Q_{Nmax} = 40 \text{ l/min}$
- $p_{max} = 350 \text{ bar}$

M22x1,5

ISO 7789

DESCRIPTION

2-way flow control valve with non-return function as a screw-in cartridge with a thread M22x1,5 for cavity according to ISO 7789. In its standard form, this flow control valve can be supplied with nine nominal volume flow ranges. For a flow at low pressure drop in the opposite direction, a check function has been integrated. The two part cartridge body is made of steel. The surface of the valve is zinc-coated for rust protection.

FUNCTION

The 2-way flow control valve is designed to keep the speed of a consumer constant, irrespective of the load. The fixed measuring orifice which is integrated into the pressure compensating spool, determines the volume flow. If there is a pressure change, the compensating spool is displaced and changes the outlet diameter in order to keep the pressure difference over the measuring orifice constant. The volume flow is adjustable with the adjustment spindle within a range of 60...100% of Q_N by changing the spring force acting on the compensating spool.

APPLICATION

For use in all hydraulic systems where the supply volume flow has to be kept constant even when the load fluctuates. Installation of the screw-in cartridge in control blocks as well as in the Wandfluh sandwich plates (vertical stacked systems) and flange valves of the NG4-Mini and NG6 size. (Please note the separate data sheets in register 2.5). Cavity tools are available for machining the cavities in steel and aluminium (hire or purchase). Please refer to the data sheets in register 2.13.

TYPE CODE

	QR	S	PM22	-	<input type="text"/>	#	<input type="text"/>
Flow control valve, 2-way, with non-return function							
Type of adjustment Screw							
Screw-in cartridge M22x1,5							
Nominal volume flow range Q_N :							
	0,6...1,0 l/min						<input type="text" value="1"/>
	1,0...1,6 l/min						<input type="text" value="1,6"/>
	1,6...2,5 l/min						<input type="text" value="2,5"/>
	2,5...4,0 l/min						<input type="text" value="4"/>
	4,0...6,3 l/min						<input type="text" value="6,3"/>
	6,3...10 l/min						<input type="text" value="10"/>
	10...16 l/min						<input type="text" value="16"/>
	16...25 l/min						<input type="text" value="25"/>
	25...40 l/min						<input type="text" value="40"/>
Design-Index (Subject to change)							

GENERAL SPECIFICATIONS

Description	2-way flow control valve
Construction	Screw-in cartridge for cavity acc. to ISO 7789
Mounting	Screw-in thread M22x1,5
Ambient temperature	-20...50 °C
Mounting position	any
Fastening torque	$M_D = 50 \text{ Nm}$
Weight	$m = 0,1 \text{ kg}$
Volume flow direction:	1 → 2 adjusted volume flow 2 → 1 free flow through by-pass check

HYDRAULIC SPECIFICATIONS

Fluid	Mineral oil, other fluid on request
Contamination efficiency	ISO 4406:1999, class 18/16/13 (Required filtration grade $\beta_{6...10} \geq 75$) refer to data sheet 1.0-50/2
Viscosity range	12 mm ² /s...320 mm ² /s
Fluid temperature	-20...+70 °C
Peak pressure	$p_{max} = 350 \text{ bar}$
Beginning of regulation	approx. 9 bar for 60% of Q_N approx. 25 bar for 100% Q_N
Influence of load pressure	< 10% of adjusted volume flow
Nominal volume flow rates	see type code
Max. volume flow	$Q_{max} = 50 \text{ l/min}$
Hysteresis	< 5% of Q_N , minimum 0,2 l/min

SYMBOLS

simplified

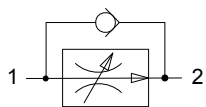

detailed

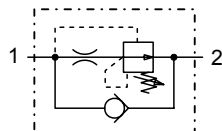
CONTROL

Screw setting	Hexagonal socket wrench s4
Control angle α_b	1440° (4 turns)

CHARACTERISTICS Oil viscosity $\nu = 30 \text{ mm}^2/\text{s}$

$Q = f(p)$ Volume flow pressure characteristics

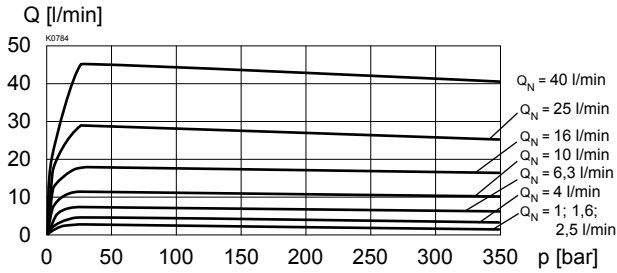

$\Delta p = f(Q)$ Pressure drop characteristics for return flow (from 2 → 1)

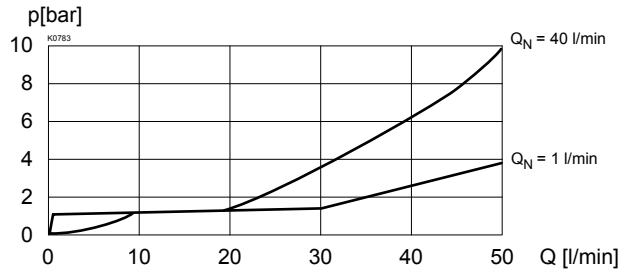

DIMENSIONS / SECTIONAL DRAWINGS

Screw setting versions „S“

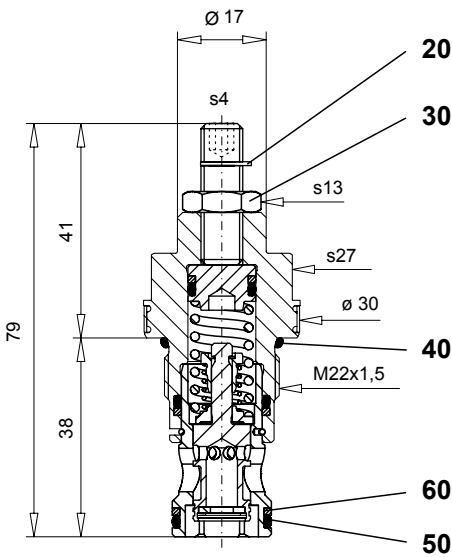

Cavity drawing according to ISO 7789-22-01-0-98

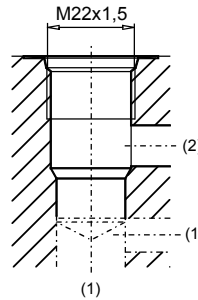

For detailed cavity drawing and cavity tools see data sheet 2.13-1008.

PARTS LIST

Position	Article	Description
20	193.1050	Retainer for shaft RD5 DIN 6799
30	153.1403	Hexagonal nut 0,5D M8
40	160.2188	O-ring ID 18,77x1,78
50	160.2156	O-ring ID 15,60x1,78
60	049.3196	Back-up ring RD 16,1x19x1,4

ACCESSORIES

Line mount body Data sheet 2.9-205

Technical explanation see data sheet 1.0-100