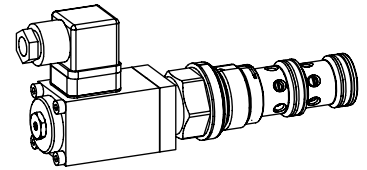

**Proportional pressure reducing valve
Screw-in cartridge**

- Pilot operated
- $Q_{max} = 160$ l/min
- $p_{max} = 400$ bar
- $p_{N red max} = 350$ bar

M33x2
 ISO 7789

DESCRIPTION

Pilot operated proportional pressure reducing valve as a screw-in cartridge with a thread M33x2 for cavity according to ISO 7789. Three standard pressure levels are available: 100, 200 and 350 bar. Adjustment by a Wandfluh proportional solenoid (VDE standard 0580). The cartridge and the solenoid made of steel are zinc coated and therefore rust-protected.

FUNCTION

The proportional pressure regulating valve controls the pressure in port A (1). Proportionally to the solenoid current solenoid force and pressure in port A (1) rises. The valve functions are practically independently of pressure in port P (2). A pressure rise in Port A (1) above the set pressure e.g. due to an active oil consumer, will be prevented by relieving excess volume flow to tank via port T (3). With deneergised solenoid the volume flow passes freely from port P to the consumer port A. Design specifically a minimum adjustable pressure according characteristic curve cannot be underpassed. To control the valve, proportional amplifiers are available from Wandfluh (see register 1.13).

APPLICATION

The valve has its application in hydraulic systems, in which the pressure frequently has to be changed. The facility for remote control and signal processing from process control systems enable elegant, comfortable solutions to problems. The screw-in cartridge is very suitable for mounting in control blocks, flange bodys and sandwich plates size NG10. Cavity tools are available for machining cavities in steel and aluminium (hire or purchase). Please refer to the data sheets in register 2.13.

CONTENT

GENERAL SPECIFICATIONS	1
HYDRAULIC SPECIFICATIONS	1
ELECTRICAL SPECIFICATIONS	1
SYMBOL	1
CHARACTERISTICS	2
DIMENSIONS/ SECTIONAL DRAWINGS	2
PART LIST	2
ACCESSORIES	2

TYPE CODE

Pressure reducing valve	M	V	P	PM33	-		-		#	
Pilot operated										
Proportional										
Screw-in thread M33x2										
Standard nominal pressure range:	$p_{N red} = 100$ bar					100				
	$p_{N red} = 200$ bar					200				
	$p_{N red} = 350$ bar					350				
Standard nominal voltage:	$U_N = 12$ VDC					G12				
	$U_N = 24$ VDC					G24				
Design-Index (Subject to change)										

• Data sheet is valid from design-index # 3 on

GENERAL SPECIFICATIONS

Denomination	Pilot operated proportional pressure reducing valve
Construction	Screw-in cartridge for cavity acc. to ISO 7789
Operation	Proportional solenoid
Mounting	Screw-in thread M33x2
Ambient temperature	-20...+50° C
Mounting position	any
Fastening torque	$M_D = 80$ Nm for screw-in cartridge $M_D = 2,6$ Nm (qual. 8.8) for solenoid screws
Weight	$m = 0,8$ kg

HYDRAULIC SPECIFICATIONS

Fluid	Mineral oil, other fluid on request
Contamination efficiency	ISO 4406:1999, class 18/16/13 (Required filtration grade $\beta_{6...10} \geq 75$) refer to data sheet 1.0-50/2
Viscosity range	12 mm ² /s...320 mm ² /s
Fluid temperature	-20...+70° C
Peak pressure	$p_{max} = 400$ bar
Nominal pressure range	$p_{N red} = 100$ bar, 200 bar and 350 bar
Volume flow range	$Q = 0...160$ l/min
Pilot- and leakage volume flow	see characteristics
Repeatability	$\leq 3\%$ *
Hysteresis	$\leq 4\%$ *
	* at optimal dither signal

ELECTRICAL SPECIFICATIONS

Construction	Proportional solenoid, wet pin push type, pressure tight.	
Standard nominal voltage	$U_N = 12$ VDC	$U_N = 24$ VDC
Limiting current	$I_G = 1250$ mA	$I_G = 680$ mA
Relative duty factor	100% DF (see date sheet 1.1-430)	
Protection class	IP 65 acc. to EN 60 529	
Connection/Power supply	Par petite fiche d'appareil, selon ISO 4400 / DIN 43 650 (2P+E)	
Other electrical specifications	see data sheet 1.1-115 (PI35MV)	

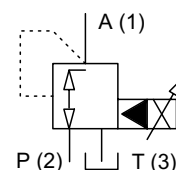
SYMBOL

CHARACTERISTICS oil viscosity $\nu = 30 \text{ mm}^2/\text{s}$
 $p_{\text{red}} = f(Q)$ Pressure volume flow characteristics
 (Maximal adjustable pressure)

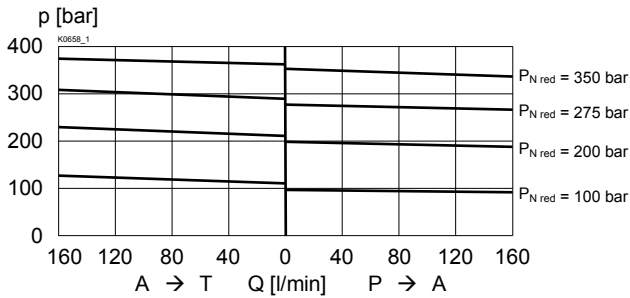

$p_{\text{red}} = f(Q)$ Pressure volume flow characteristics
 (Minimal adjustable pressure)
 * Consumption resistance dependent on system

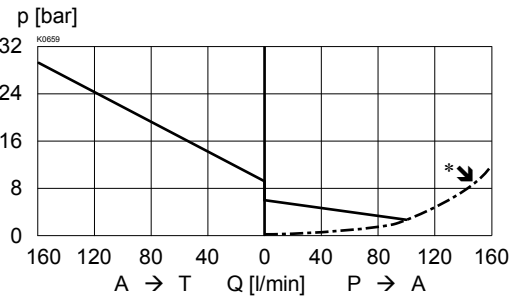

$p_{\text{red}} = f(I)$ Pressure adjustment characteristics
 [at $Q = 0 \text{ l/min}$ (static)]

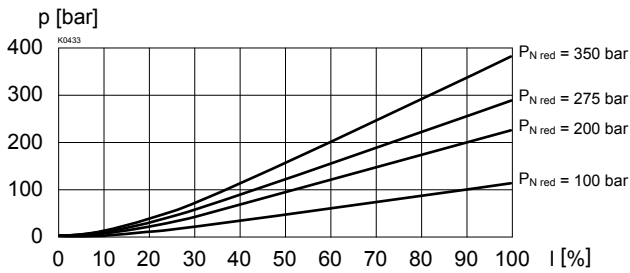

$Q_{\text{st+L}} = f(p_{\text{red}})$ Pilot- and leakage volume flow characteristic
 [A (1) → T (3)]

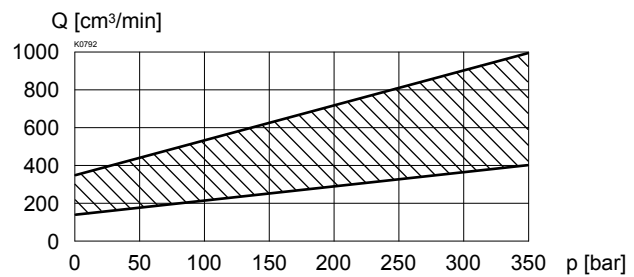

DIMENSIONS/SECTIONAL DRAWINGS

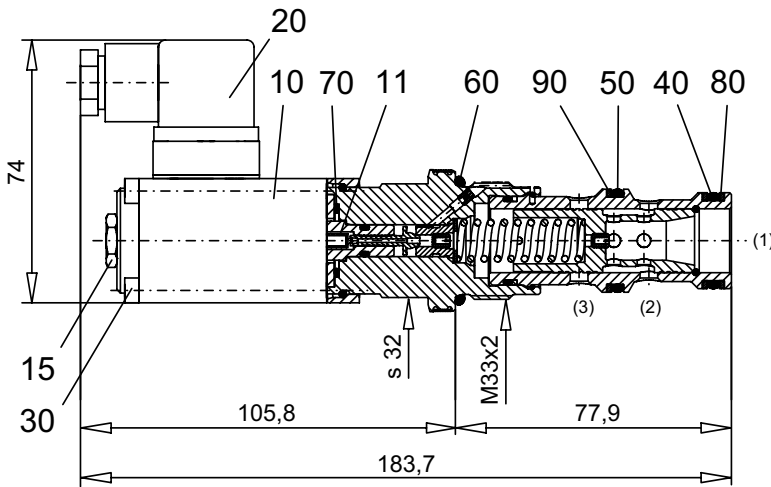

Cavity drawing acc. to
 ISO 7789-33-04-0-98

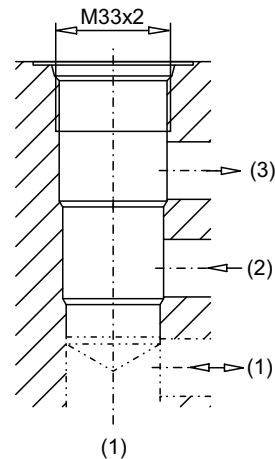

For detailed cavity drawing
 see data sheet 2.13-1040

PARTS LIST

Position	Article	Description
10	256.3505 256.3443	Proportional solenoid PI35MV-G24 Proportional solenoid PI35MV-G12
11	034.0116	Pin RD 4x8
15	253.8000	Mounted screw with integrated manual override HB4,5
20	219.2002	Plug (black)
30	246.1161	Socket head cap screw M4x60 DIN 912
40	160.2219	O-ring ID 21,89x2,62
50	160.2235	O-ring ID 23,47x2,62
60	160.2298	O-ring ID 29,82x2,62
70	160.2170	O-ring ID 17,17x1,78
80	049.3277	Back-up ring RD 22,5x27x1,4
90	049.3297	Back-up ring RD 24,5x29x1,4

ACCESSORIES

Cartridge built into flange - or sandwich body
 Proportional-Amplifier

register 1.13

Technical explanation see data sheet 1.0-100E