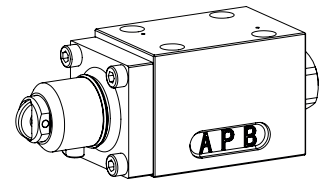

Spool valve

Flange construction

- ◆ roller operated
- ◆ 4/2-way with spring reset
- ◆ $Q_{max} = 80$ l/min
- ◆ $p_{max} = 350$ bar

NG6

ISO 4401-03

DESCRIPTION

Direct operated valve, roller operated with 4 connections in 5 chamber design. Without actuation, the spool is switched back to the offset position.

APPLICATION

Spool valves are mainly used for controlling direction of movement and stopping of hydraulic cylinders and motors. The direction of movement is determined by the position of the spool and its symbol. Manually or mechanically operated valves are particularly suitable for use in installations where no electric current is available or for applications in explosion hazard areas.

TYPE CODE

Spool valve, direct operated		WD	T	F	A06	-	<input type="text"/>	-	<input type="text"/>	#	<input type="text"/>
Roller with spring reset											
Flange construction											
International standard interface ISO, NG6											
Designation of symbols acc. to table	Operation a-side	<input type="text" value="...1"/>									
	Operation b-side	<input type="text" value="...2"/>									
Sealing material	NBR	<input type="text"/>									
	FKM (Viton)	<input type="text" value="D1"/>									
Design index (subject to change)											

1.5-46

GENERAL SPECIFICATIONS

Designation	4/2-spool valve
Construction	Direct operated
Mounting	Flange construction
Nominal size	NG6 according to ISO 4401-03
Actuation	Roller operated
Ambient temperature	-25...+70 °C (NBR) -20...+70 °C (FKM)
Weight	1,27 kg

ACTUATION

Actuation	Roller
Actuation stroke	s = 2,6 mm
Actuation force	$F_b = 110 - 135$ N at p_{Tmax}

HYDRAULIC SPECIFICATIONS

Working pressure	$p_{max} = 350$ bar
Tank pressure	$p_{Tmax} = 100$ bar
Maximum volume flow	$Q_{max} = 80$ l/min, see characteristics
Leakage oil	See characteristics
Fluid	Mineral oil, other fluid on request
Viscosity range	12 mm ² /s...320 mm ² /s
Temperature range fluid	-25...+70 °C
Contamination efficiency	Class 20 / 18 / 14
Filtration	Required filtration grade $\beta_{10...16} \geq 75$, see data sheet 1.0-50

SYMBOL
Overview valves

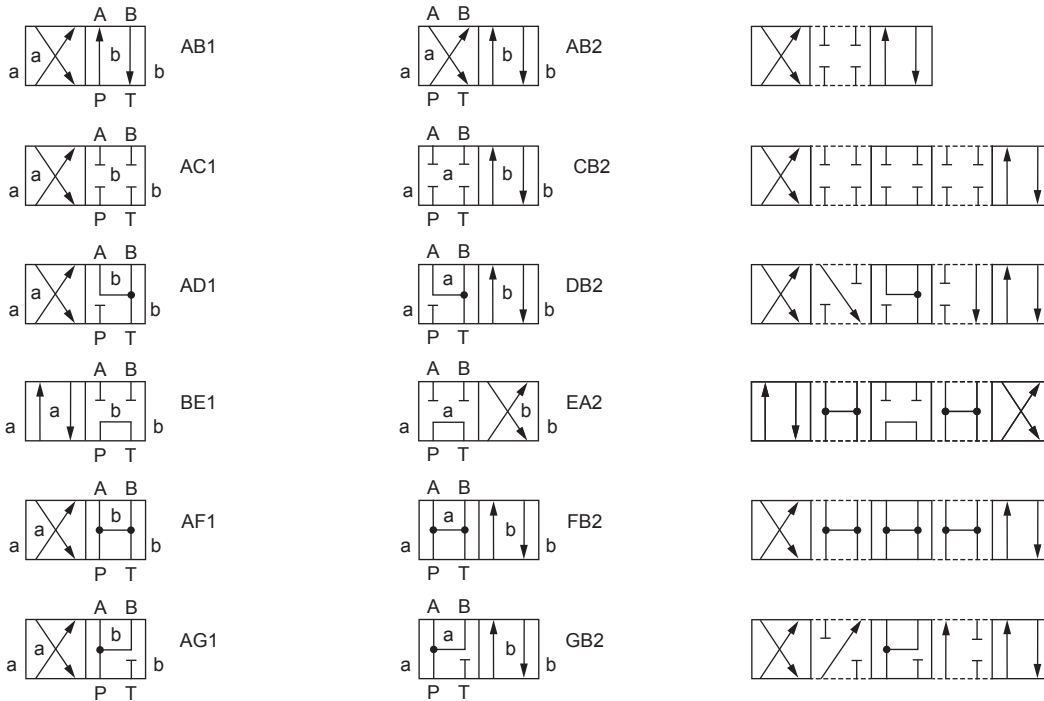
Overview spool types

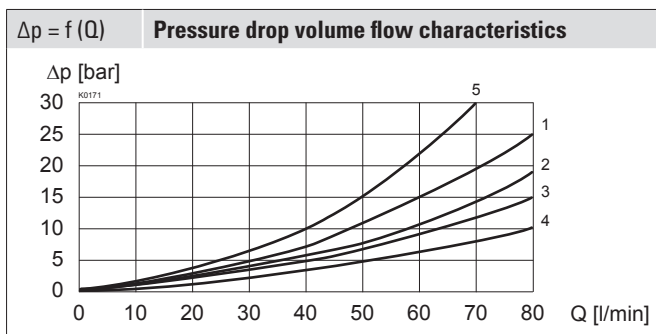
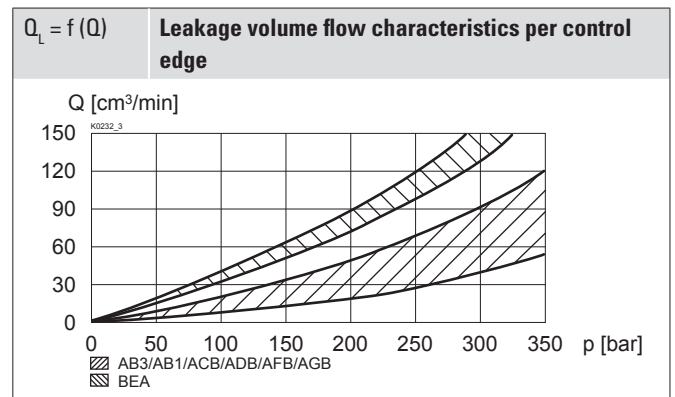
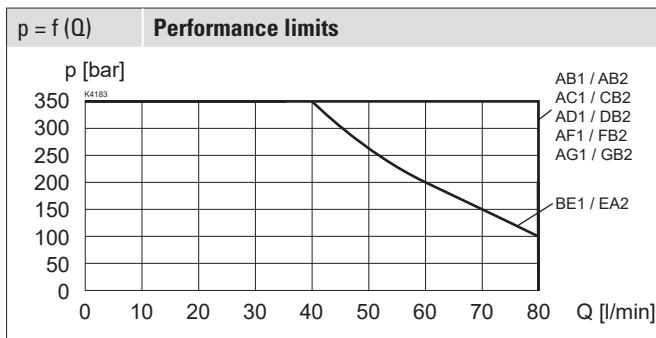
PERFORMANCE SPECIFICATIONS

 Oil viscosity $\nu = 30 \text{ mm}^2/\text{s}$

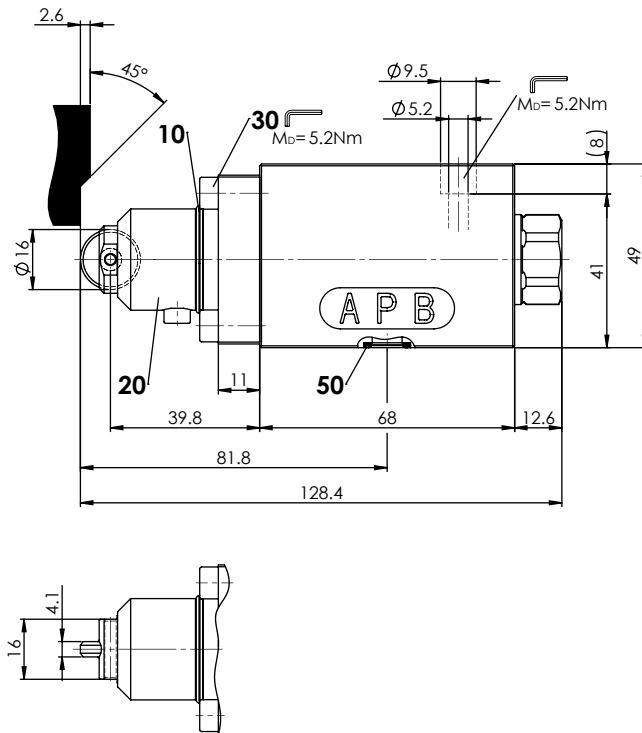
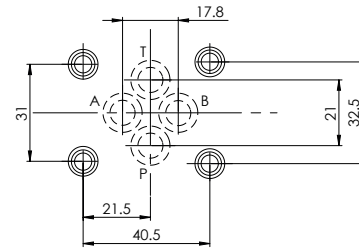
Symbole	Volume flow direction				
	P - A	P - B	P - T	A - T	B - T
AB1 / AB2	2	2	-	1	1
AC1 / CB2	2	2	-	1	1
AD1 / DB2	2	2	-	3	3
BE1 / EA2	2	2	5	2	2
AF1 / FB2	4	4	-	3	3
AG1 / GB2	4	4	-	1	1

DIMENSIONS

HYDRAULIC CONNECTION

PARTS LIST

Position	Article	Description
10	160.2236	O-ring ID 23,52 x 1,78 (NBR)
20	253.6000	Mechanical control head ATII
30	246.2119	Socket head screw M5 x 18 DIN 912
50	160.2093	O-ring ID 9,25 x 1,78 (NBR)
	160.6092	O-ring ID 9,25 x 1,78 (FKM)

ACCESSORIES

Fixing screws	Data sheet 1.0-60
Threaded subplates	Data sheet 2.9-30
Multi-station subplates	Data sheet 2.9-60
Horizontal mounting blocks	Data sheet 2.9-100
Technical explanations	Data sheet 1.0-100
Hydraulic fluids	Data sheet 1.0-50
Filtration	Data sheet 1.0-50

SEALING MATERIAL

NBR or FKM (Viton) as standard, choice in the type code

STANDARDS

Mounting interface	ISO 4401-03
Contamination efficiency	ISO 4406

INSTALLATION NOTES

Mounting type	Flange mounting 4 fixing holes for socket head screws M5 x 50
Mounting position	Any, preferably horizontal
Tightening torque	Fixing screws $M_b = 5,2 \text{ Nm}$ (screw quality 8.8, zinc coated)

Note!

The length of the fixing screw depends on the base material of the connection element.

SURFACE TREATMENT

- ◆ The valve body is painted with a two component paint
- ◆ The roller housing and the cover are zinc-nickel coated

Wandfluh AG Postfach CH-3714 Frutigen
 Tel. +41 33 672 72 72 Fax +41 33 672 72 12 sales@wandfluh.com