

Proportional spool valve stainless

Flange construction

- ◆ $Q_{max} = 30 \text{ l/min}$
- ◆ 3 volume flow levels
- ◆ $Q_{Nmax} = 20 \text{ l/min}$
- ◆ $p_{max} = 350 \text{ bar}$

NG6

ISO 4401-03

- Ex db IIC T6, T4 Gb (Zone 1)
- Ex tb III C T80 °C, T130 °C Db (Zone 21)
- Ex db I Mb
- ⊕ II 2 G Ex db IIC T6, T4
- ⊕ II 2 D Ex tb III C T80 °C, T130 °C
- ⊕ I M2 Ex db I Mb
- Class I, Division 1, Group A, B, C, D T4
- Class II & III, Division I, Group E, F, G T4

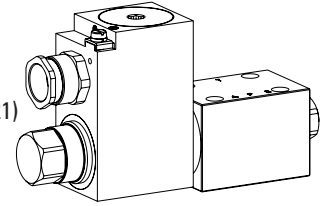

DESCRIPTION

Direct operated proportional spool valve with 4 connections in 5-chamber system. Precise spool fit, low leakage, long service life time. Proportional to the solenoid current, the spool stroke, the spool opening and the valve volume flow increase. The pressure tight encapsulated Ex-protection solenoid coil prevents an explosion on the inside penetrating to the outside as well as an ignitable surface temperature.

APPLICATION

These valves are suitable for applications in explosion-hazard areas, open cast and also in mines. The stainless execution is especially suitable for the use in wet and salty environment. Proportional spool valves are perfectly suitable for demanding tasks due to the high resolution, large volume flow and low hysteresis. The applications are in the industrial as well as in the mobile hydraulics for the smooth control of hydraulic actuations.

CERTIFICATES

	Surface	Mining	Standard -25 °C to...	M248 Electronic
ATEX / UKEX	x	x	x	x
IECEX	x	x	x	x
CCC	x	x	x	x
EAC	x	x	x	x
Australia	x	x	x	
MA		x	x	x
USA / Canada	x		x	x
PESO	x		x	x

The certificates can be found on www.wandfluh.com

ACTUATION

Actuation	Proportional solenoid, wet pin push type, pressure tight
Execution	MKY45 / 18x60 (Data sheet 1.1-183)
Connection	Cable gland for cable Ø 6,5... 14 mm

Attention! The UC execution is always supplied without cable gland



SYMBOL

Symmetrical control

ACB-S

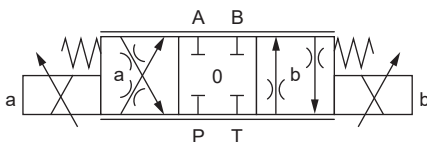

AC1-S

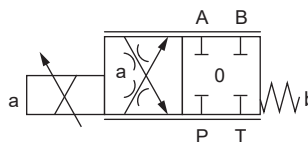

CB2-S

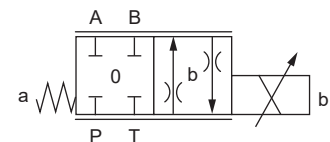

Meter-in control

ADB-V

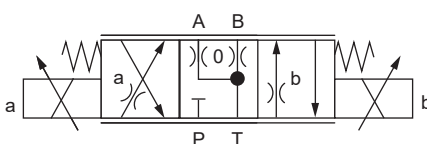

AD1-V

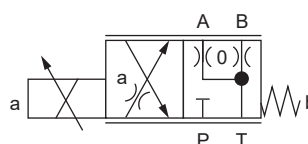

DB2-V

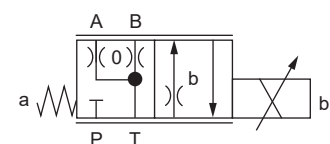

TYPE CODE

WD B F A06 - - - / / - K9 # 2

Spool valve, direct operated

Proportional, explosion proof execution Ex d

Flange construction

International standard interface ISO, NG6

Designation of symbols acc. to table

Nominal volume flow Q_N	L15		L9 ACB-S		L9 ADB-V	
	6 l/min	<input type="text" value="6"/>	3 l/min	<input type="text" value="3"/>	5 l/min	<input type="text" value="5"/>
	12 l/min	<input type="text" value="12"/>	7 l/min	<input type="text" value="7"/>	10 l/min	<input type="text" value="10"/>
	20 l/min	<input type="text" value="20"/>	14 l/min	<input type="text" value="14"/>	16 l/min	<input type="text" value="16"/>

Nominal voltage U_N	12 VDC	<input type="text" value="G12"/>
	24 VDC	<input type="text" value="G24"/>

Nominal power P_N

	9 W	<input type="text" value="L9"/>	Ambient temperature up to: 40 °C or 90 °C 70 °C
	15 W	<input type="text" value="L15"/>	

Certification

ATEX, UKEX, IECEx, CCC, EAC	<input type="text"/>	USA / Canada	<input type="text" value="UC-M187"/>	
	Australia			India
	MA			<input type="text" value="PE"/>

Sealing material

NBR	<input type="text"/>
FKM (Viton)	<input type="text" value="D1"/>

Amplifier

Stainless

Design index (subject to change)
1.10-88S

GENERAL SPECIFICATIONS

Designation	Proportional spool valve
Construction	Direct operated
Mounting	Flange construction
Nominal size	NG6 according to ISO 4401-03
Actuation	Ex-protection proportional solenoid
Ambient temperature	Operation as T6 -25...+40 °C (L9) Operation as T4 -25...+90 °C (L9) -25...+70 °C (L15)
Weight	3,1 kg (1 solenoid) 4,9 kg (2 solenoids)
MTTFd	150 years

ELECTRICAL SPECIFICATIONS

Protection class	IP65 / 66 / 67
Relative duty factor	100 % DF
Voltage tolerance	± 10 % with regard to nominal voltage
Standard nominal voltage	12 VDC, 24 VDC
Limiting current at... °C	L15 / 70 °C: $I_G = 445 \text{ mA}$ ($U_N = 24\text{VDC}$) $I_G = 890 \text{ mA}$ ($U_N = 12\text{VDC}$) L9 / 40 °C: $I_G = 305 \text{ mA}$ ($U_N = 24\text{VDC}$) $I_G = 610 \text{ mA}$ ($U_N = 12\text{VDC}$) L9 / 90 °C: $I_G = 265 \text{ mA}$ ($U_N = 24\text{VDC}$) $I_G = 530 \text{ mA}$ ($U_N = 12\text{VDC}$)
Standard nominal power	9 W, 15 W
Temperature class	Nominal power 9 W: T1...T6 Nominal power 15 W: T1...T4

Note!

Other electrical specifications see data sheet 1.1-183

HYDRAULIC SPECIFICATIONS

Working pressure	$p_{max} = 350 \text{ bar}$
Tank pressure	$p_{Tmax} = 160 \text{ bar}$
Maximum volume flow	$Q_{max} = 30 \text{ l/min}$, see characteristics
Nominal volume flow	$Q_N = 6 \text{ l/min}$, 12 l/min, 20 l/min (L15) $Q_N = 3 \text{ l/min}$, 7 l/min, 14 l/min (L9 ACB-S) $Q_N = 5 \text{ l/min}$, 10 l/min, 16 l/min (L9 ADB-V)
Leakage oil	On request
Hysteresis	L15 / 70°C: $\leq 10 \%$ at optimal dither signal L9 / 40°C: $\leq 12 \%$ at optimal dither signal L9 / 90°C: $\leq 14 \%$ at optimal dither signal
Fluid	Mineral oil, other fluid on request
Viscosity range	12 mm ² /s...320 mm ² /s
Temperature range fluid	Operation as T6 NBR -25...+40 °C (L9) FKM -20...+40 °C (L9) Operation as T4 NBR -25...+70 °C (L9 or L15) FKM -20...+70 °C (L9 or L15)
Contamination efficiency	Class 18 / 16 / 13
Filtration	Required filtration grade $\beta_{6...10} \geq 75$, see data sheet 1.0-50

Attention! With the execution L9 for ambient temperatures up to 90 °C (L9/90 °C), Q_N is not reached

STANDARDS

Explosion protection	Directive 2014 / 34 / EU (ATEX)
Flameproof enclosure	EN / IEC / UL 60079-1, 31
Cable entry	EN 60079-0, 1, 7, 15, 31
Mounting interface	ISO 4401-03
Protection class	EN 60 529
Contamination efficiency	ISO 4406

SURFACE TREATMENT

- ◆ The valve body, the cover and the socket head screws are made of stainless steel
- ◆ The slip-on coil and the armature tube are zinc nickel coated

SEALING MATERIAL

NBR or FKM (Viton) as standard, choice in the type code

PERFORMANCE SPECIFICATIONS

Oil viscosity $\nu = 30 \text{ mm}^2/\text{s}$

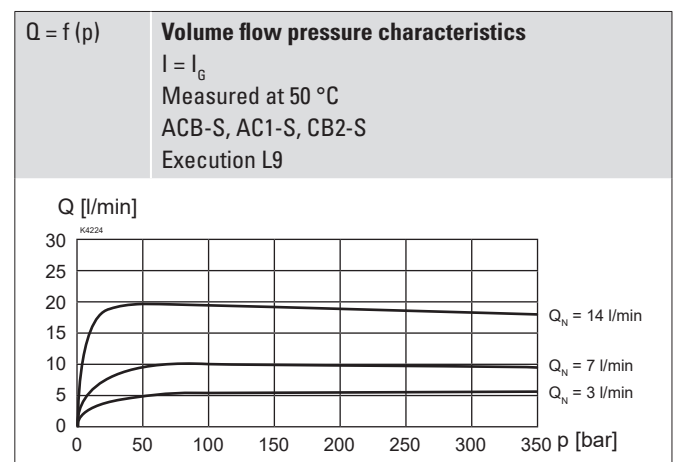
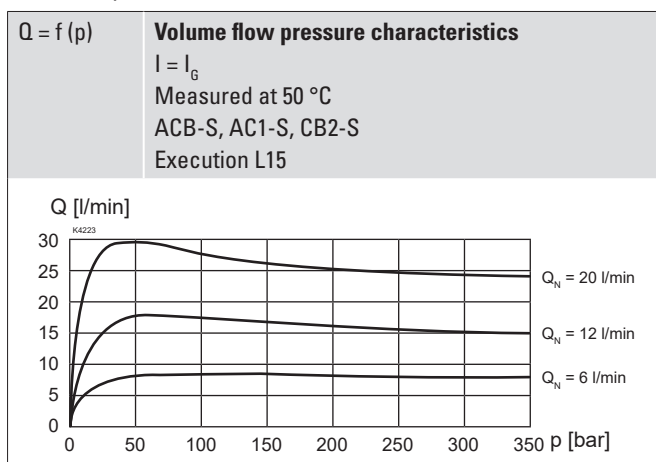

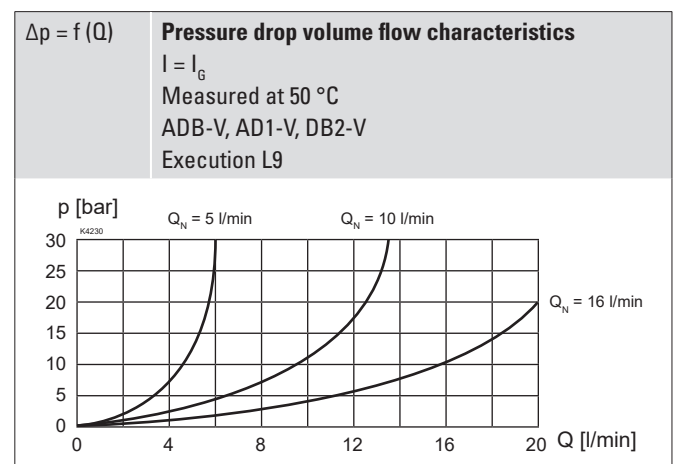
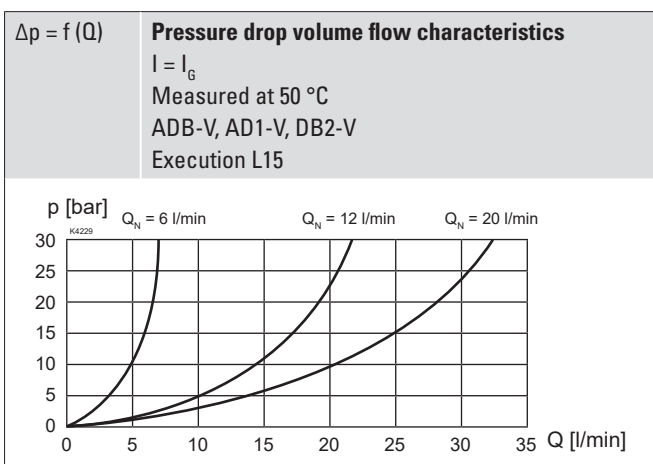
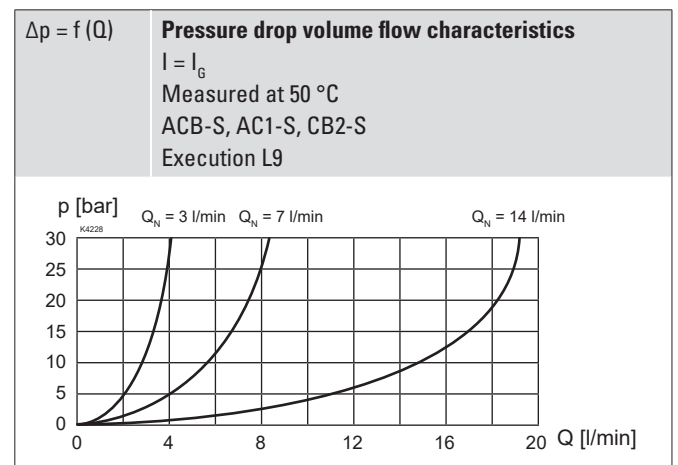
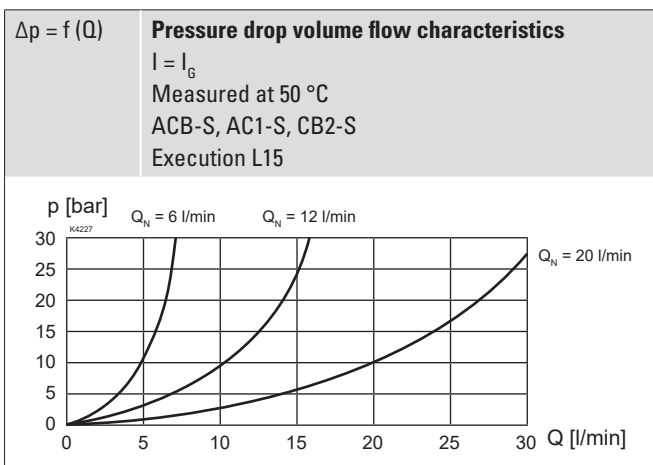
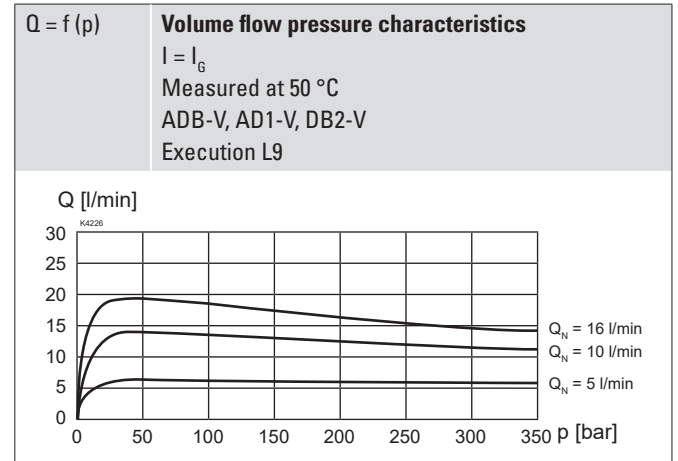
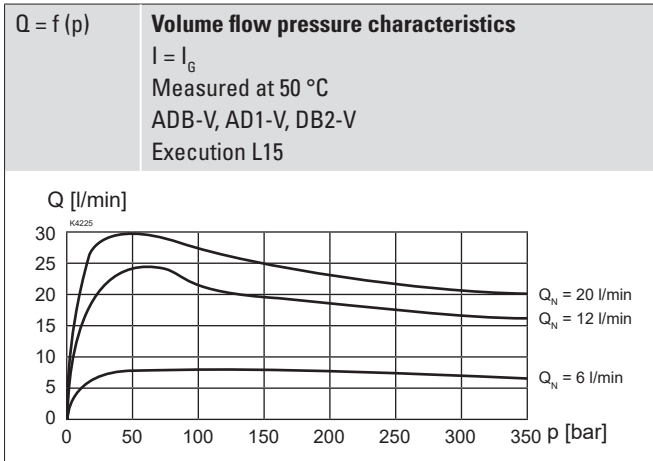

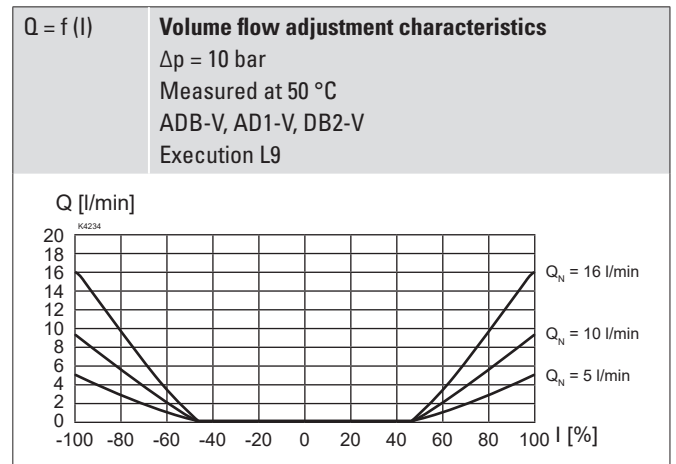
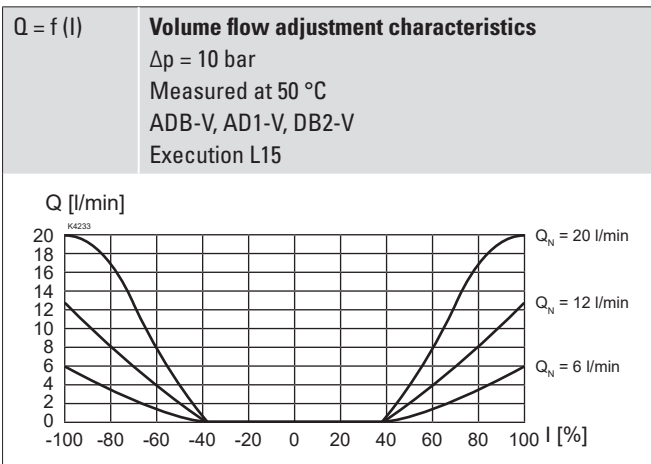
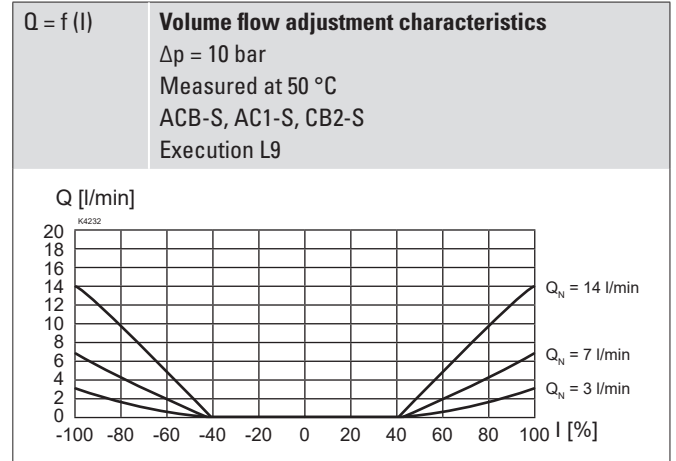
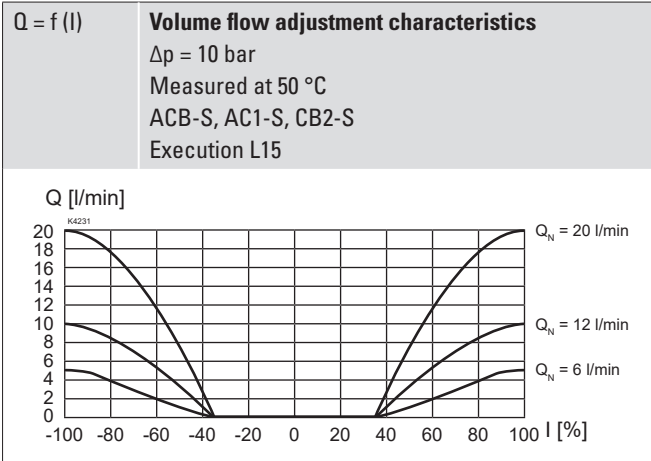

Note! All values were measured over two control edges. The connections A and B were short-circuited.

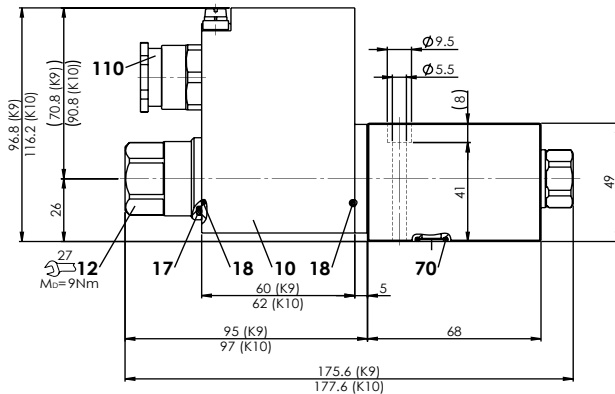
DIMENSIONS
4/2-way spool valve

Dimensions of the solenoid coil, refer to data sheet 1.1-183

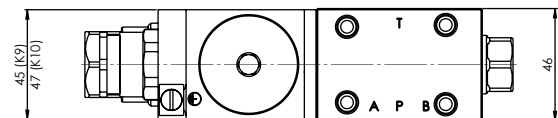
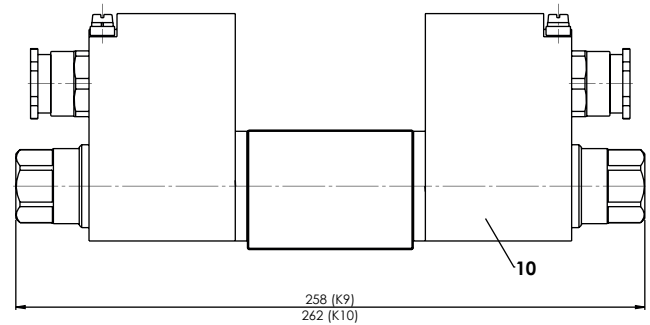
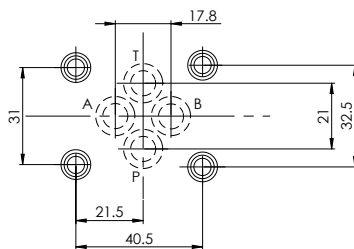
4/3-way spool valve

HYDRAULIC CONNECTION

PARTS LIST

Position	Article	Description
10	263.6...	Solenoid coil MK.45 / 18 x 60
12	154.220.	Knurled nut Ex M18 x 1,5 x 30-K..
110	111.1080	Cable gland M20 x 1,5
	251.2218	Seal kit WDYFA06

Seal kit consisting of

17	O-ring	ID 25,07 x 2,62
18	O-ring	ID 17,17 x 1,78
70	O-ring	ID 9,25 x 1,78

INSTALLATION NOTES

Mounting type	Flange mounting 4 fixing holes for socket head screws M5 x 50
Mounting position	Any, preferably horizontal
Tightening torque	Fixing screws $M_0 = 5,1 \text{ Nm}$ (screw quality A4) $M_0 = 9 \text{ Nm}$ knurled nut

Note!  The length of the fixing screw depends on the base material of the connection element.

Attention!  For stack assembly please observe the remarks in the operating instructions

ACCESSORIES

Technical explanations	Data sheet 1.0-100
Filtration	Data sheet 1.0-50
Relative duty factor	Data sheet 1.1-430