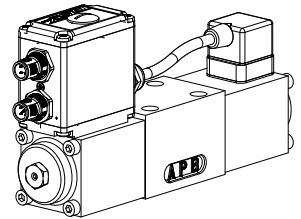

Proportional directional control valve

- **Integrated amplifier or controller electronics**
- **Direct operated, not pressure compensated**
- **Q_{max} = 40 l/min**
- **Q_N = 32 l/min**
- **p_{max} = 350 bar**

DESCRIPTION

Direct operated proportional spool valve with integrated electronics in flange design NG6 acc. to ISO 4401-03 / 7790 with 4 ports. These plug & play valves are factory set and adjusted. High valve-to-valve reproducibility. Housing for electronics with protection class IP67 for harsh environment. The spool valve is designed acc. to the 5 chamber principle. The volume flow is adjusted by a Wandfluh proportional solenoid (VDE standard 0580). Low pressure drop due to the body design and spool profiling. The spool is made of hardened steel. The body made of high grade hydraulic casting is painted. The solenoids are zinc coated and the housing for the electronics is made of aluminium.

FUNCTION

Proportionally to the command signal applied to the electronics spool stroke, metering opening and volume flow increase. The control connection is provided by an analog interface or a fieldbus interface (CANopen or Profibus DP). Parameter setting and diagnosis with the free-of-charge software «PASO» or via fieldbus interface. Data are stored in a non volatile memory. Even after an electric power failure settings can easily be reproduced and transmitted. These valves are available with an integrated controller as an option. As feedback signal source sensors with voltage or current output signal can be directly connected. The available controller structure has been optimised for applications with hydraulic actuators.

APPLICATION

Proportional directional spool valves with integrated electronics are well suited for demanding applications where high resolution, high volume flow and low hysteresis are requested. They are implemented in systems calling for good valve-to-valve reproducibility, easy installation, comfortable operation and high precision in industrial hydraulics as well as in mobile hydraulics for the smooth control of actuators. The integrated controller relieves the machine control system and operates the axis (position, angle, pressure, etc.) in a closed control loop. Application examples: pitch control of wind generators, forest and earth moving machines, machine tools and paper production machines with simple position controls, robotics and fan control.

CONTENT

GENERAL SPECIFICATIONS.....	1
TYPE CHARTS/ DESIGNATIONS OF SYMBOLS	2
HYDRAULIC SPECIFICATIONS	2
ELECTRICAL SPECIFICATIONS.....	2
CONNECTOR WIRING DIAGRAM	2
START-UP	3
CHARACTERISTICS.....	3
DIMENSIONS.....	4
PARTS LIST	4
ACCESSORIES (not incl. in the delivery).....	4

TYPE CODE

	WD V F A06 - <input type="checkbox"/> - <input type="checkbox"/> - <input type="checkbox"/> - <input type="checkbox"/> # <input type="checkbox"/>								
Directional control valve, direct operated	<input type="checkbox"/>								
Proportional valve with integrated electronics	<input type="checkbox"/>								
Flange version	<input type="checkbox"/>								
International standard interface ISO, nominal size 6	<input type="checkbox"/>								
Designation of symbols acc. to table 1.10-80/2	<input type="checkbox"/>								
Nominal volume flow ranges Q _N :	<table border="1" style="display: inline-table; border-collapse: collapse;"> <tr> <td>5 l/min</td> <td><input type="checkbox"/></td> <td>16 l/min</td> <td><input type="checkbox"/></td> </tr> <tr> <td>10 l/min</td> <td><input type="checkbox"/></td> <td>32 l/min</td> <td><input type="checkbox"/></td> </tr> </table>	5 l/min	<input type="checkbox"/>	16 l/min	<input type="checkbox"/>	10 l/min	<input type="checkbox"/>	32 l/min	<input type="checkbox"/>
5 l/min	<input type="checkbox"/>	16 l/min	<input type="checkbox"/>						
10 l/min	<input type="checkbox"/>	32 l/min	<input type="checkbox"/>						
Standard nominal voltage U _N :	<table border="1" style="display: inline-table; border-collapse: collapse;"> <tr> <td>12 VDC</td> <td><input type="checkbox"/></td> </tr> <tr> <td>24 VDC</td> <td><input type="checkbox"/></td> </tr> </table>	12 VDC	<input type="checkbox"/>	24 VDC	<input type="checkbox"/>				
12 VDC	<input type="checkbox"/>								
24 VDC	<input type="checkbox"/>								
Hardware configuration:									
With analog signal (-10...+10 V factory set)	<input type="checkbox"/> A2								
With CANopen acc. to DSP-408	<input type="checkbox"/> C1								
With Profibus DP in accordance with Fluid Power Technology	<input type="checkbox"/> P1								
With CAN J1939 (on request)	<input type="checkbox"/> J1								
Functions:									
Amplifier	<input type="checkbox"/> no remark								
Controller with current feedback signal (0...20 mA / 4...20 mA)	<input type="checkbox"/> R1								
Controller with voltage feedback signal (0...10 V)	<input type="checkbox"/> R2								
Design-Index (Subject to change)	<input type="checkbox"/>								

GENERAL SPECIFICATIONS

Designation	4/3-way proportional valve with integrated electronics	Ambient temperature	-20...+65°C (typical) <small>(The upper temperature limit is a guideline value for typical applications, in individual cases it may also be higher or lower. The electronics of the valve limit the power in case of a too high electronics temperature. More detailed information can be obtained from the operating instructions «DSV».)</small>
Nominal size	NG6-Mini acc. to ISO 4401-03/7790	Mounting position	any, preferably horizontal
Construction	Direct operated spool valve	Fastening torque	M _D = 5,5 Nm (quality 8.8)
Operations	Proportional solenoid, wet pin push type, pressure tight	Weight	m = 2,8 kg
Mounting	Flange, 4 fixing holes for socket head cap screws M5x50		
Connections	Threaded connection plates, multi-flange subplates, longitudinal stacking system		

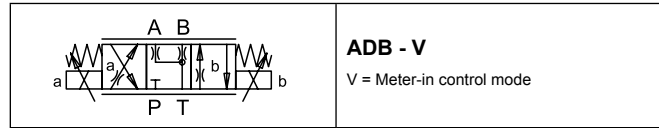
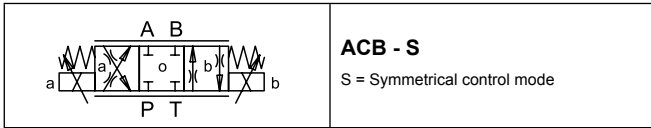
TYPE CHARTS / DESIGNATIONS OF SYMBOLS

HYDRAULIC SPECIFICATIONS

Fluid	Mineral oil, other fluid on request
Contamination efficiency	ISO 4406:1999, class 18/16/13 (Required filtration grade $\beta_{6...10} \geq 75$) refer to data sheet 1.0-50/2
Viscosity range	12 mm ² /s...320 mm ² /s
Fluid temperature	-20...+70 °C
Working pressure	$p_{max} = 350$ bar (connections P, A, B)
Tank pressure	$p_{max} = 160$ bar (connections T)
Nominal volume flow	$Q_N = 5$ l/min, 10 l/min, 16 l/min, 32 l/min
Max. volume flow	see characteristic
Leakage volume flow	on request
Hysteresis	≤ 5%

ELECTRICAL SPECIFICATIONS

Protection class	IP 67 acc. to EN 60 529 with suitable connector and closed electronic housing
Supply voltage	12 VDC or 24 VDC
Ramps (amplifier only)	separate adjustment for up and down for each solenoid
Preset value generator (controller only)	preset value speed adjustable
Parameterisation Interface	via fieldbus or USB USB (Mini B) for parameterisation with «PASO» (under the closing screw of the housing cover, factory set parameters)
Analog interface (MAIN):	
Device receptacle (male)	M23, 12-poles
Mating connector	Plug (female), M23, 12-poles (not incl. in delivery)
Preset value signal:	Voltage/current selected with software
Fieldbus interface:	
Device receptacle supply (male)	M12, 4-poles
Mating connector	Plug (female), M12, 4-poles (not incl. in delivery)
Device receptacle CANopen (male)	M12, 5-poles (acc. to DRP 303-1)
Mating connector	Plug (female), M12, 5-poles (not incl. in delivery)
Device receptacle Profibus (female)	M12, 5-poles, B-coded (acc. to IEC 947-5-2)
Mating connector	Plug (male), M12, 5-poles, B-coded (not incl. in delivery)
Preset value signal:	Fieldbus
Sensor interface: (controller only)	
Device receptacle sensor (female)	M12, 5-poles
Mating connector	Plug (male), M12, 5-poles (not incl. in delivery)
Feedback signal:	Voltage/current, state when ordering

NOTE!

Detailed electrical characteristics and description of «DSV» electronics are shown on data sheet 1.13-75.

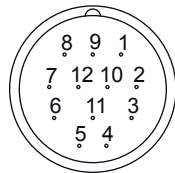
CONNECTOR WIRING DIAGRAM
Analog interface:
Device receptacle (male) X1

- 1 = Supply voltage +
- 2 = Supply voltage 0 VDC
- 3 = Stabilised output voltage
- 4 = Preset value voltage +
- 5 = Preset value voltage -
- 6 = Preset value current +
- 7 = Preset value current -
- 8 = Reserved for extensions
- 9 = Reserved for extensions
- 10 = Enable control (Digital input)
- 11 = Error signal (Digital output)
- 12 = Chassis

Preset value voltage (PIN 4/5) resp. current (PIN 6/7) are selected with set-up and diagnosis software.

Factory setting: Voltage (-10...+10 V), (PIN 4/5)

Fieldbus interface:
Device receptacle supply (male) X1

MAIN

- 1 = Supply voltage +
- 2 = Reserved for extensions
- 3 = Supply voltage 0 VDC
- 4 = Chassis

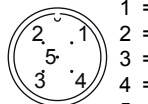
Device receptacle CANopen (male) X3

CAN

- 1 = not connected
- 2 = not connected
- 3 = CAN Gnd
- 4 = CAN High
- 5 = CAN Low

Device receptacle Profibus (female) X3

PROFIBUS

- 1 = VP
- 2 = Rx/D / Tx/D - N
- 3 = DGND
- 4 = Rx/D / Tx/D - P
- 5 = Shield

Parameterisation interface (USB, Mini B) X2

Under the closing screw of the housing cover

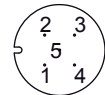
Feedback signal interface
Device receptacle Sensor (female) X4 (controller only)

- 1 = Supply voltage (output) +
- 2 = Feedback signal +
- 3 = Supply voltage 0 VDC
- 4 = not connected
- 5 = stab. output voltage

NOTE!

The mating connectors and the cable to adjust the settings are not part of the delivery. To order the cable, look up the article no. in the chapter «Accessories».

START-UP

Normally there is no need to adjust settings by the customer. The connectors have to be wired according to the chapter «Connector wiring diagram».

Controllers will be supplied configured as amplifiers. Switching into controller mode and setting of the adjustments of the controller must be done by the customer using the set-up software (USB interface, Mini B)

Additional information can be found on our website:
«www.wandfluh.com»

Free-of-charge download of the «PASO»-software and the instruction manual for the «**DSV**» hydraulic valves as well as the operation instruction **CANopen** protocol eg. **Profibus DP** protocol with device profile DSP-408 for «**DSV**».

CHARACTERISTICS Oil viscosity $\nu = 30 \text{ mm}^2/\text{s}$

$Q = f(p)$ Volume flow pressure characteristics ($s = 100\%$)
 [Type: ACB-S]

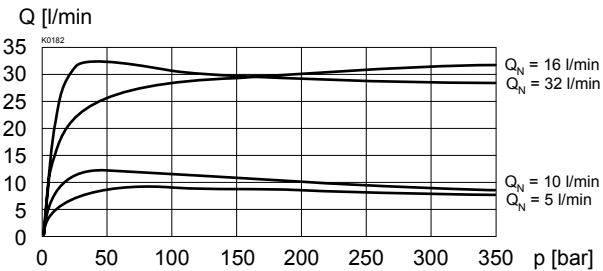

$Q = f(p)$ Volume flow pressure characteristics ($s = 100\%$)
 [Type: ADB-V]

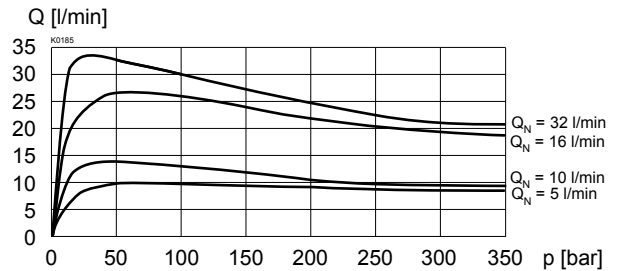

$\Delta p = f(Q)$ Pressure loss/flow characteristics ($s = 100\%$)
 [Type: ACB-S]

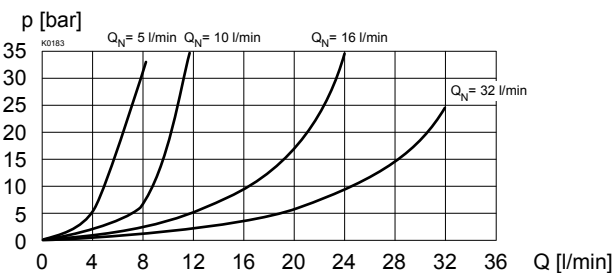

$\Delta p = f(Q)$ Pressure loss/flow characteristics ($s = 100\%$)
 [Type: ADB-V]

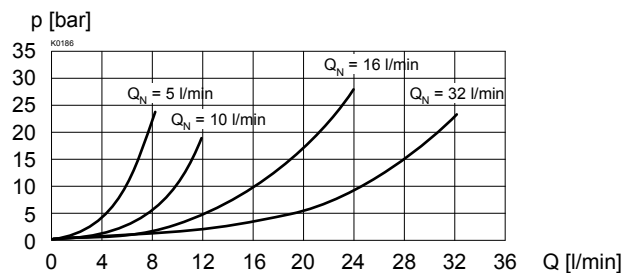

$Q = f(s, x)$ Volume flow-signal-characteristics ($\Delta p = 10 \text{ bar}$)
 [Type: ACB-S]
 (s corresponds to preset value signal and x corresponds to spool stroke)

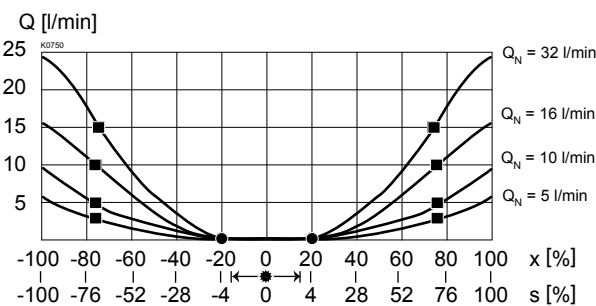

$Q = f(s, x)$ Volume flow-signal-characteristics ($\Delta p = 10 \text{ bar}$)
 [Type: ADB-V]
 (s corresponds to preset value signal and x corresponds to spool stroke)

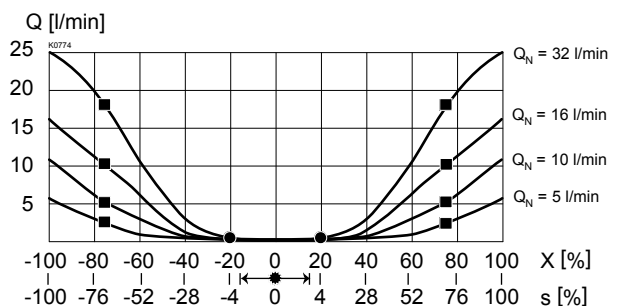
Factory settings:

Dither set for optimal hysteresis

- ✱ = Deadband: Both solenoids switched off with command signal $-2\% \dots +2\%$
- = Opening point: at command signal $\pm 4\%$
- = Flow at $\Delta p = 10 \text{ bar}$ over 2 metering edges at command signal $\pm 70\%$
 15,0 l/min for $Q_N = 32 \text{ l/min}$
 9,4 l/min for $Q_N = 16 \text{ l/min}$
 4,4 l/min for $Q_N = 10 \text{ l/min}$
 2,7 l/min for $Q_N = 5 \text{ l/min}$

Factory settings:

Dither set for optimal hysteresis

- ✱ = Deadband: Both solenoids switched off with command signal $-2\% \dots +2\%$
- = Opening point: at command signal $\pm 4\%$
- = Flow at $\Delta p = 10 \text{ bar}$ over 2 metering edges at command signal $\pm 70\%$
 16,5 l/min for $Q_N = 32 \text{ l/min}$
 10,5 l/min for $Q_N = 16 \text{ l/min}$
 5,5 l/min for $Q_N = 10 \text{ l/min}$
 3,0 l/min for $Q_N = 5 \text{ l/min}$



NOTE!

All values measured over 2 metering edges, A and B ports linked.

DIMENSIONS
With analog interface
 Amplifier and controller

NOTE!

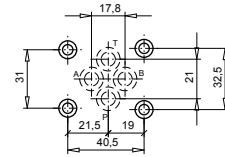
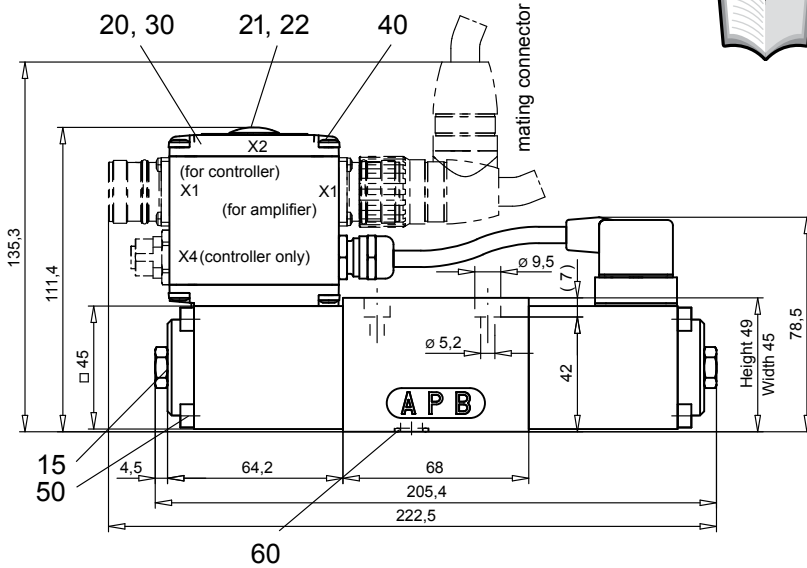
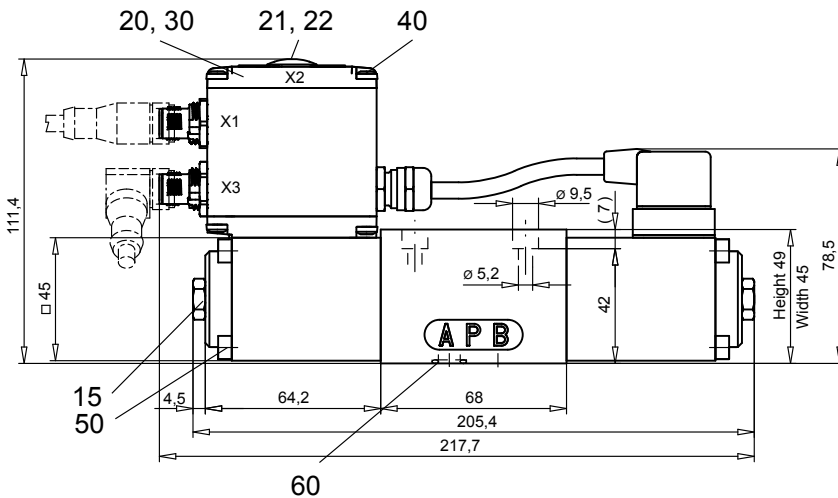
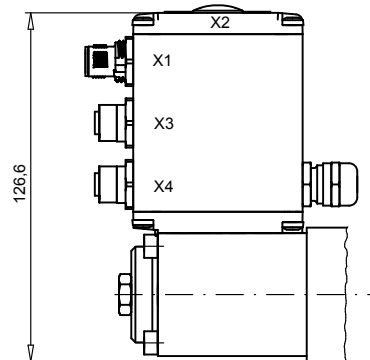
The cable connector is not part of the delivery. The dimensions refer to those of the cable connector in the chapter «Accessories».

With Fieldbus interface
 Amplifier

With Fieldbus interface
 Controller

PARTS LIST

Position	Article	Description
15	253.8001	Plug with integrated manual override HB6
20	062.0102	Cover
21	223.1317	Dummy plug M16x1,5
22	160.6131	O-ring ID 13,00x1,5
30	072.0021	Gasket 33x2x59,9x2
40	208.0100	Socket head cap screw M4x10
50	246.2160	Socket head cap screw M5x60 DIN 912
60	160.2093	O-ring ID 9,25x1,78

ACCESSORIES

- Set-up software see start-up
 - Cable to adjust the settings through interface USB (from plug type A to Mini B, 3m) article no. 219.2896
 - Cable connector for analog interface:
 - straight, soldering contact article no. 219.2330
 - 90°, soldering contact article no. 219.2331
- Recommended cable size:
- Outer diameter 9...10,5 mm
 - Single wire max. 1 mm²
 - Recommended wire size:
 - 0...25 m = 0,75 mm² (AWG18)
 - 25...50 m = 1 mm² (AWG17)

Technical explanation see data sheet 1.0-100E