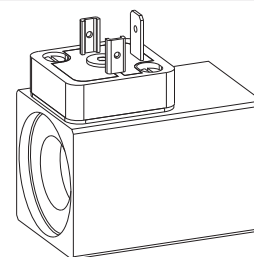

**Solenoid coil M.S35/19x50
 to VDE 0580
 Protection class IP65/IP67**

DESCRIPTION

The slip-on solenoid coil M.S35/19x53 is available with different types of electric connections. The AC voltage type incorporates a rectifier. The available AC voltages are listed in the type code section. The construction corresponds to standard VDE 0580. The steel housing is zinc-/nickel-coated as standard.

FUNCTION

In combination with the corresponding armature tube the function of an on-off solenoid or proportional solenoid will be obtained.

TYPE CODE

Metal housing, square		M <input type="checkbox"/> S35/19x50 - <input type="checkbox"/> <input type="checkbox"/> - <input type="checkbox"/> # <input type="checkbox"/>	
Connection execution			
Connector socket EN175301-803/ISO4400	<input type="checkbox"/> D	Flying leads	<input type="checkbox"/> L (only DC)
Connector socket AMP Junior-Timer	<input type="checkbox"/> J (only DC)	Cable	<input type="checkbox"/> K
Connector Deutsch DT04-2P	<input type="checkbox"/> G (only DC)	Bayonet connector VG 95234	<input type="checkbox"/> B
		Screw clamp	<input type="checkbox"/> X (only DC)
Coil execution			
Internal coil diameter 19 mm			
Coil length 50 mm			
Voltage	Direct current	<input type="checkbox"/> G	Alternating current
Nominal voltage	12 VDC	<input type="checkbox"/> 12	115 VAC
	24 VDC	<input type="checkbox"/> 24	230 VAC
Standard		<input type="checkbox"/>	
Special cable execution		<input type="checkbox"/> M28	
With pressure compensation		<input type="checkbox"/> M35 (only DC)	
Special screw clamp		<input type="checkbox"/> M209 (only DC)	
Screw clamp and electric wiring		<input type="checkbox"/> M222 (only DC)	
Design-Index (Subject to change)			

SPECIFICATIONS

Coil winding	min. H (180 °C)		12 VDC	24 VDC	115 VAC	230 VAC
insulation class		Nominal power (W)	26	26	26	26
Protection class	depending on the connector version IP65 or IP67 according to EN 60 529 (if correctly mounted)	Limiting power (W)	16	16	-	-
Relative duty factor	100 % DF / 5 min	Limiting current (50 °C)(A)	1,36	0,68	-	-
Ambient temperature	when mounted on armature tube and valve	Nominal resistance (Ω)	5,6	22	410	1650
Nominal voltage range	See temperature curve on page 4	Number of windings (-)	718	1400	6100	11850
	10-250 VDC	Weight of solenoid coil (kg)	0,32	0,32	0,32	0,32
	24-250 VAC					
Corrosion protection	Salt spray test in accordance with EN ISO 9227 > = 1000 hours					

SAFE OPERATION

 **Caution:** To avoid overheating the coil may only be energised when mounted on an armature tube and valve.



NOTE!

The effective heat emissions depends on the installation conditions (heat emission surface, air circulation, etc.), these influence the described area of application.

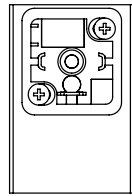
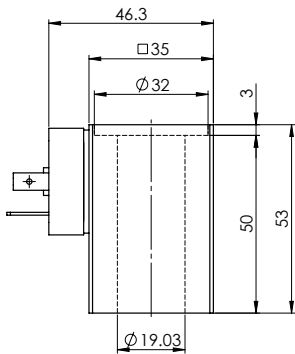
TYPE LISTE/DIMENSIONS/GENERAL SPECIFICATIONS

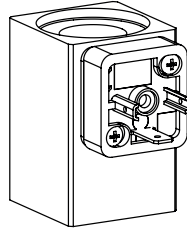

Valve side



Execution: M **D** S35/19x50-...

- 3 pole 2 P+E
 - DC- and AC-execution available
 - Connector socket plastic
 - Protection class IP65
- With corresponding mating connector (not included in delivery) and professional assembly

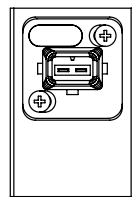
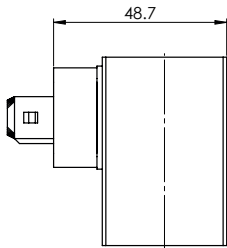

Valve side

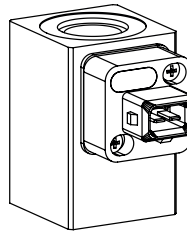

Execution: M **J** S35/19x50-...

- 2 pole 2P
 - DC-execution available
 - only for $U_N \leq 75$ VDC
 - Connector socket plastic
 - Protection class IP65
- With corresponding mating connector (not included in delivery) and professional assembly

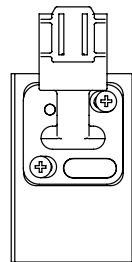
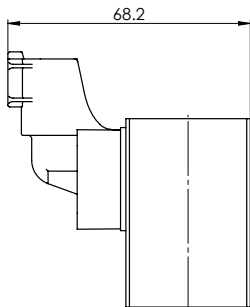

Valve side

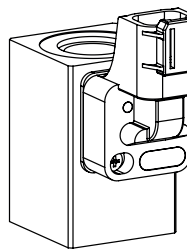

Execution: M **G** S35/19x50

- 2 pole 2P
 - DC-execution available
 - only for $U_N \leq 75$ VDC
 - Protection class IP 67 and 69 K
- With corresponding mating connector (not included in delivery) and professional assembly

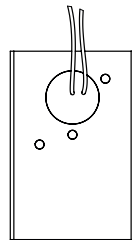
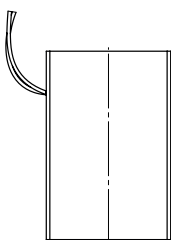

Valve side

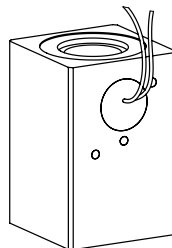

Execution: M **L** S35/19x50-...

- 2 pole 2P (2x 0,25 mm²) Radox 155
 - Cable length 500 mm
 - DC-execution available
 - nur für $U_N \leq 75$ VDC
 - Protection class IP65
- With professional assembly

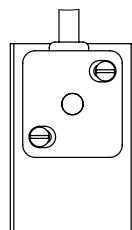
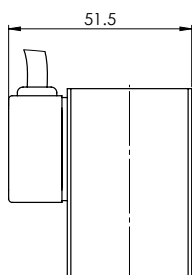

Valve side

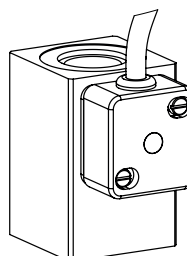

Execution: M **K** S35/19x50-...

- 3 pole 2P+E 3x 0,75 mm² Thermoplast
 - Cable length 1500 mm
 - Cable diameter 6 mm
 - DC- and AC-execution available
 - Cable housing plastic
 - Protection class IP67
- With professional assembly

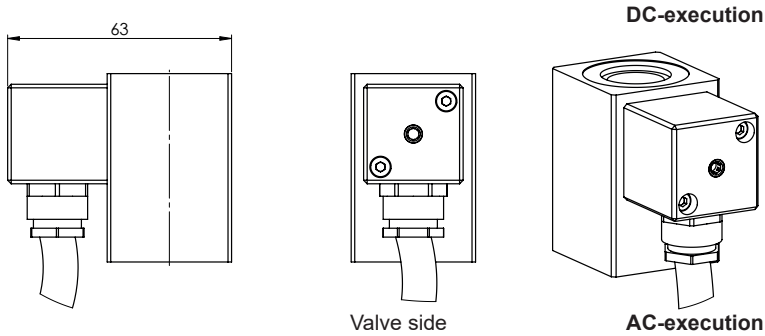

Execution: M **K** S35/19x50-... **M28**

- 3 pole 2P+E 2x 1 mm² [E]
(acc. to IEC 332)
- Cable length 1500 mm
- DC- and AC-execution available
- Connector housing steel
- Protection class IP67
With professional assembly

- Plastic rectifier housing, h+10,5 mm

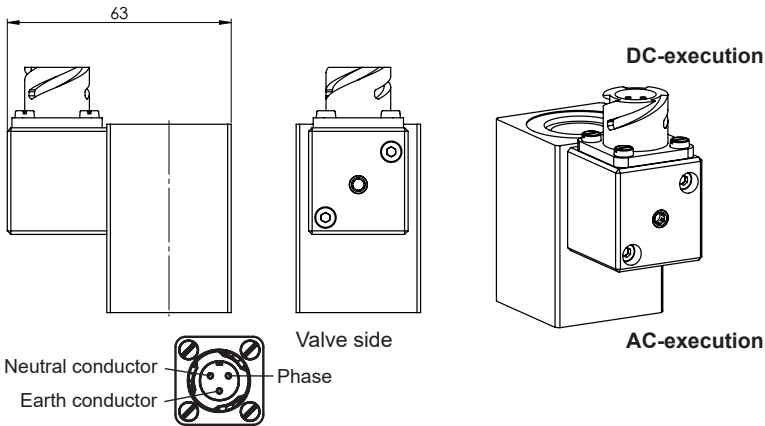

Execution: M **B** S35/19x50-...

- 3 pole 2P+E
- MiL VG 95234
- DC- and AC-execution available
- Connector housing steel
- Protection class IP67
With corresponding mating connector
(not included in delivery)
and professional assembly

- Plastic rectifier housing, h+10,5 mm

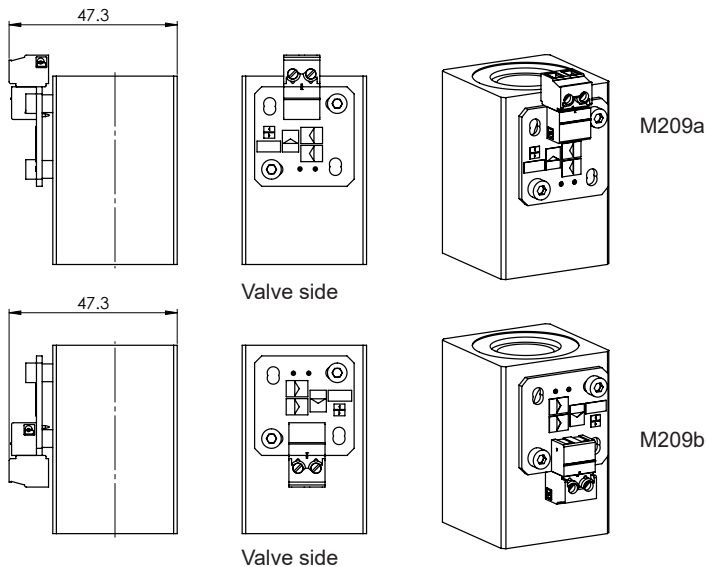

Execution: M **X** S35/19x50-... **M209**

- 2 pole
- DC-version available up to 28 VDC
- Screw clamp plastic
- Printed circuit board protected with
conformal coating

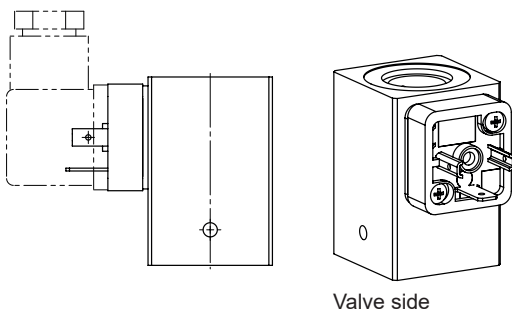

Execution: M . S35/19x50-... **M35**
M . S35/19x50-... **M../35**

- With pressure equalising bore for underwater
applications in oil bath
- Oil tank separated from water by a membrane
- With connection type «D», «L», «X»
- DC-execution available

Attention:
In case of the connection execution «D» only
plugs with the additional designation «Z23»
must be utilised (not included in the scope of
supply of the solenoid)

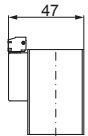
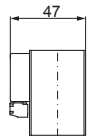
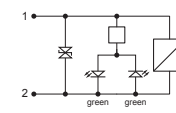
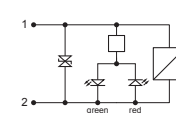
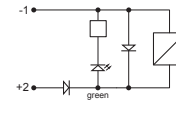
Plug alignment		Electric wiring
		
M222a	M222b	
M222c	M222d	
M222e	M222f	 Not recommended for proportional solenoids

Execution: M S35/19x50-... **M222**

- 2 pole
- DC-version available up to 28 VDC
- Screw clamp plastic
- Plug housing plastic, transparent, removable
- Printed circuit board protected with conformal coating
- Protection type IP40 with plastic hood installed

* $I_{max} = 1,0 \text{ A at } 130 \text{ }^\circ\text{C}$
 $I_{max} = 1,5 \text{ A at } 120 \text{ }^\circ\text{C}$
 $I_{max} = 2,0 \text{ A at } 110 \text{ }^\circ\text{C}$

PARTS LIST

Position	Article	Description
10	219.2802	Mating connector (M209 und M222)
20	088.1116	Plastic hood (only M222)

M222b/d/f

M222a/c/e

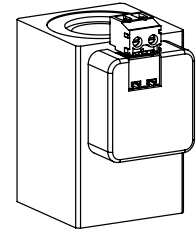
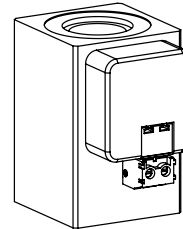

Valve side



NOTE!

Technical explanation see data sheet 1.1-400/410/430

DUTY FACTOR / TEMPERATURE

TEMPERATURE / VOLTAGE

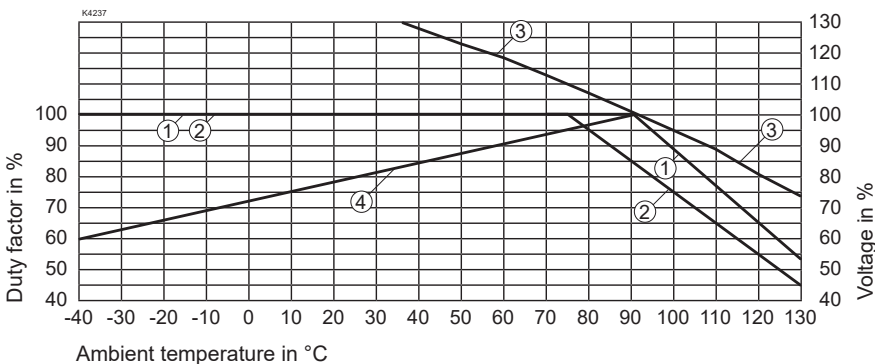

- ① Duty factor at nominal voltage
- ② Duty factor at 110% nominal voltage
- ③ Max. voltage in % for 100% duty factor
- ④ Min. voltage in % for proportional limiting current at 100% duty factor