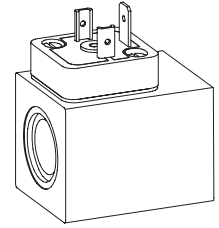

**Solenoid coil M.E35/16x40
 to VDE 0580
 Protection class IP65/IP67**

DESCRIPTION

The slip-on solenoid coil M.S35/16x40 is available with different types of electric connections. The AC voltage type incorporates a rectifier. The available AC voltages are listed in the type code section. The construction corresponds to standard VDE 0580. The steel housing is zinc-/nickel-coated as standard.

FUNCTION

In combination with the corresponding armature tube the function of an on-off solenoid or proportional solenoid will be obtained.

TYPE CODE

Metal housing, square		M		<input type="checkbox"/>	E35/16x40 -	<input type="checkbox"/>	<input type="checkbox"/>	-	<input type="checkbox"/>	#	<input type="checkbox"/>
Connection execution											
Connector socket EN175301-803/ISO 4400	<input type="checkbox"/> D	Flying leads execution		<input type="checkbox"/> L	(only DC)						
Connector socket AMP Junior-Timer	<input type="checkbox"/> J	(only DC)									
Connector Deutsch DT04-2P	<input type="checkbox"/> G	(only DC)									
		Screw clamp		<input type="checkbox"/> X	(only DC)						
Coil execution											
Internal coil diameter 16 mm											
Coil length 40 mm											
Voltage	Direct current	<input type="checkbox"/> G	Alternating current	<input type="checkbox"/> R							
Nominal voltage	12 VDC	<input type="checkbox"/> 12	115 VAC	<input type="checkbox"/> 115							
	24 VDC	<input type="checkbox"/> 24	230 VAC	<input type="checkbox"/> 230							
Standard		<input type="checkbox"/>									
With pressure compensation		<input type="checkbox"/> M35		(only DC)							
Special screw clamp		<input type="checkbox"/> M209		(only DC)							
Screw clamp and electric wiring		<input type="checkbox"/> M222		(only DC)							
Design-Index (Subject to change)											

SPECIFICATIONS

Coil winding insulation class	min. H (180 °C)
Protection class	depending on the connector version IP65 or IP67 according to EN 60 529 (if correctly mounted)
Relative duty factor	100 % ED / 5 min when mounted on armature tube and valve
Ambient temperature	See temperature curve
Nominal voltage range	10–250 VDC 24–250 VAC
Corrosion protection	Salt spray test in accordance with EN ISO 9227 > = 1000 hours

	12 VDC	24 VDC	115 VAC	230 VAC
Nominal power (W) (Switching function)	19,5	20,5	20	16,8
Nominal resistance (Ω)	7,4	28	525	2525
Weight of solenoid coil (kg)	0,28	0,28	0,28	0,28

SAFE OPERATION

Caution: To avoid overheating the coil may only be energised when mounted on an armature tube and valve.

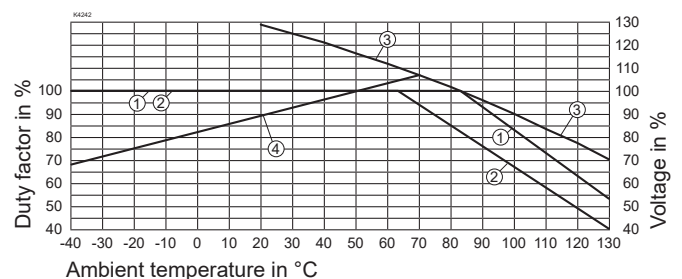
DUTY FACTOR
VOLTAGE

- ① Duty factor at nominal voltage
- ② Duty factor at 110 % nominal voltage
- ③ Max. voltage in % for 100 % duty factor
- ④ Min. voltage in % for proportional limiting current at 100 % duty factor

NOTE!

The effective heat emissions depends on the installation conditions (heat emission surface, air circulation, etc.), these influence the described area of application.

TYPE LISTE/DIMENSIONS/GENERAL SPECIFICATIONS

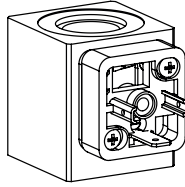
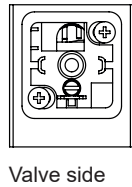
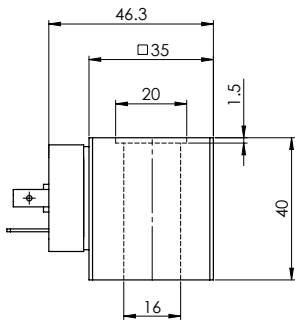

Execution: M **D** S35/16x40-...

- 3-pole 2 P+E
 - DC- and AC-execution available
 - Connector socket plastic
 - Protection class IP65
- With corresponding mating connector (not included in delivery) and professional assembly

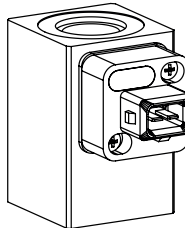
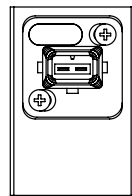
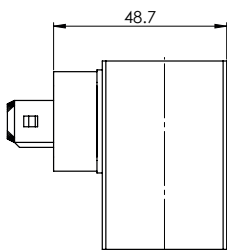

Execution: M **J** S35/16x40-...

- 2-pole 2P
 - DC-execution available
 - only for $U_N \leq 75$ VDC
 - Connector socket plastic
 - Protection class IP65
- With corresponding mating connector (not included in delivery) and professional assembly

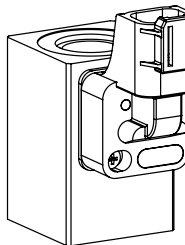
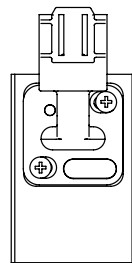
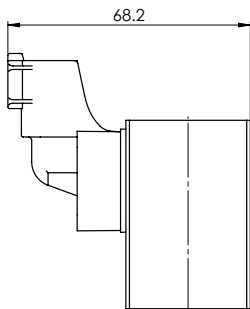

Execution: M **G** S35/16x40

- 2-pole 2P
 - DC-execution available
 - only for $U_N \leq 75$ VDC
 - Protection class IP 67 and 69 K
- With corresponding mating connector (not included in delivery) and professional assembly

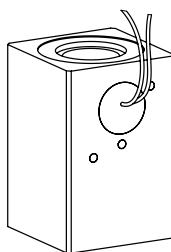
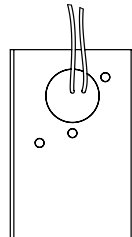
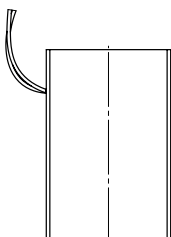

Execution: M **L** S35/16x40-...

- 2-pole 2P (2x 0,25 mm²) Radox 155
 - Cable length 500 mm
 - DC-execution available
 - only for $U_N \leq 75$ VDC
 - Protection class IP65
- With professional assembly

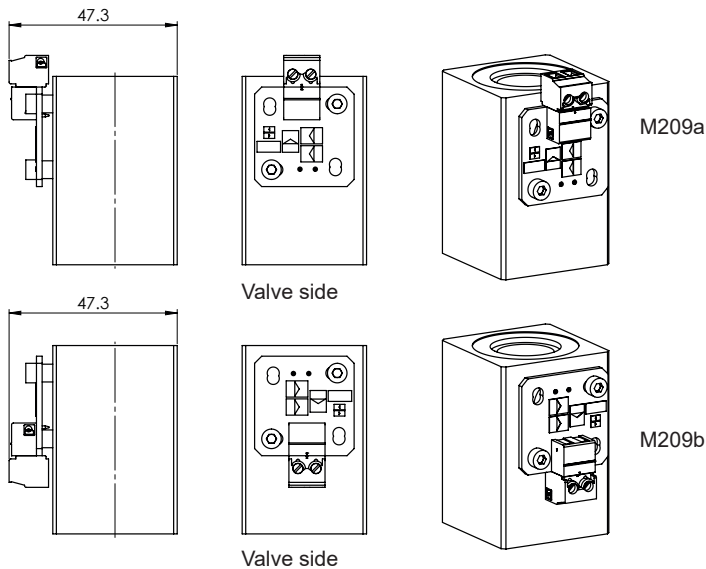

Execution: M S35/16x40-... **M209**

- 2-pole
- DC-version available up to 28 VDC
- Screw clamp plastic
- Printed circuit board protected with conformal coating

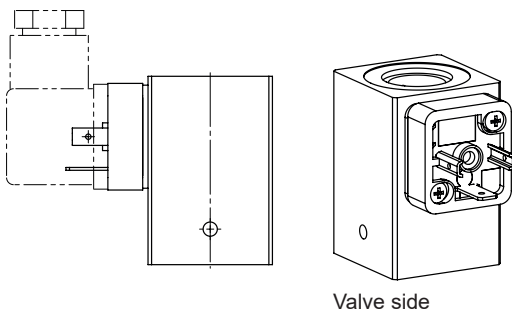

Execution: M . S35/16x40-... **M35**
M . S35/16x40-... **M../35**

- With pressure equalising bore for underwater applications in oil bath
- Oil tank separated from water by a membrane
- With connection type «D», «L», «X»
- DC-execution available

Attention:
In case of the connection execution «D» only plugs with the additional designation «Z23» must be utilised (not included in the scope of supply of the solenoid)